

Алюминиевый порожек

**AT-674**  
**T= 1.5**  
**m= 0.158**

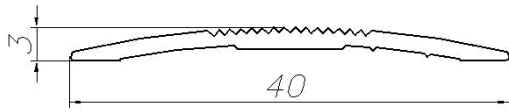

**AT-675**  
**T= 2**  
**m = 0,170**

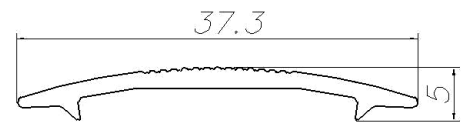

**AT-678**  
**T= 1.3**  
**m = 0.174**

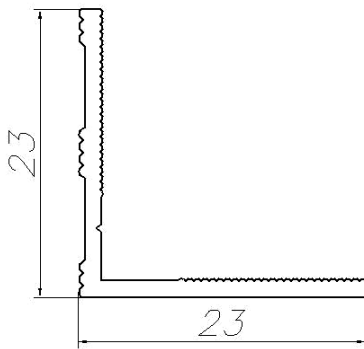

**AT-681**  
**T= 1.5**  
**m = 0.105**

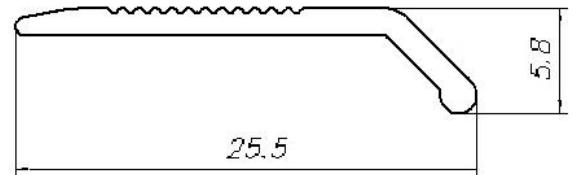

**AT-682**  
**T= 1.5**  
**m = 0.126**

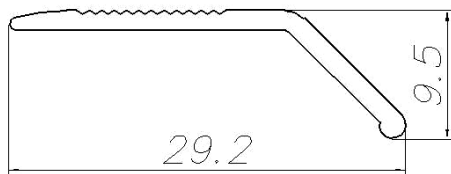

**AT-683**  
**T= 1.5**  
**m = 0.166**

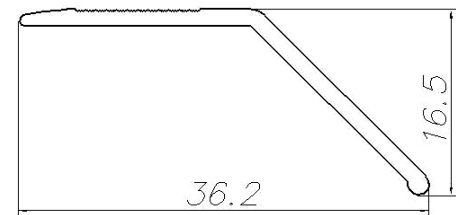

**AT-674**  
**T= 1.5**  
**m= 0.158**

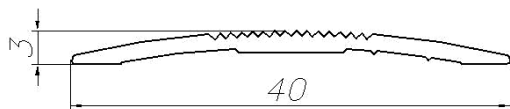

**AT-675**  
**T= 2**  
**m = 0,170**

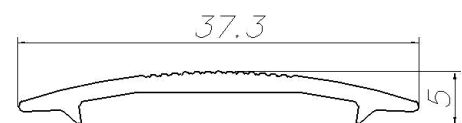

Алюминиевый порожек

**AT-678**  
**T= 1.3**  
**m = 0.174**

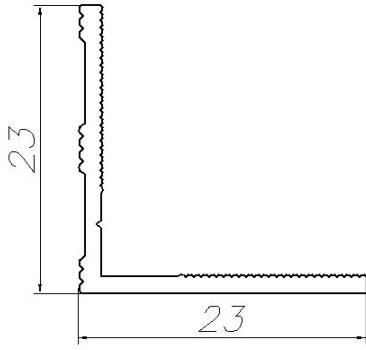

**AT-681**  
**T=**  
**Вес п/м**

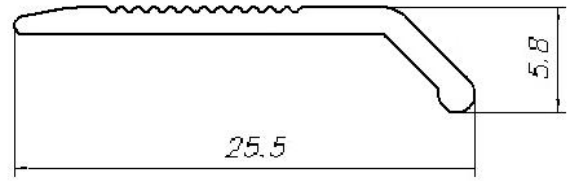

**AT-682**  
**T= 1.5**  
**m = 0.126**

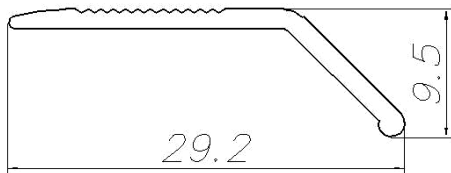

**AT-683**  
**T= 1.5**  
**m = 0.166**

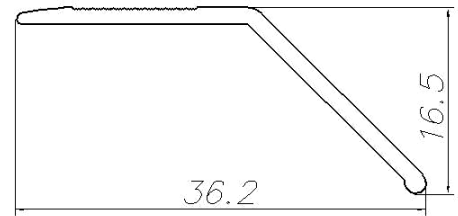

**AT-685**  
**T=**  
**m = 0.311**

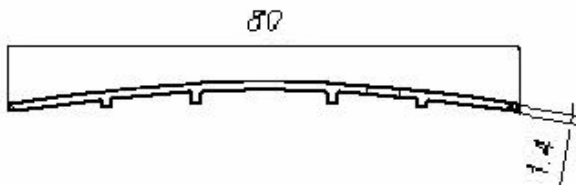

**AT-1005**  
**T=**  
**m = 0.311**

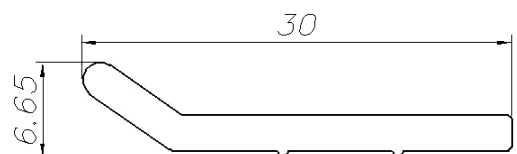

**AT-1060**  
**T=**  
**m = 0.180**

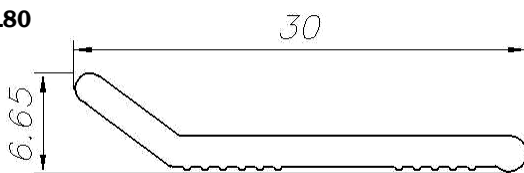

**AT-1094**  
**T= 1.7**  
**m = 0.095**

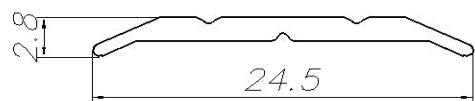

Алюминиевый порожек

**AT-1095**  
**T= 1.7**  
**m = 0.104**

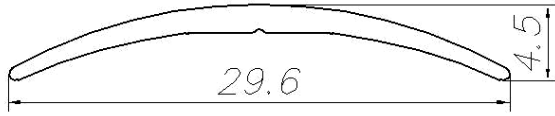

**AT-1096**  
**T=**  
**m = 0.134**

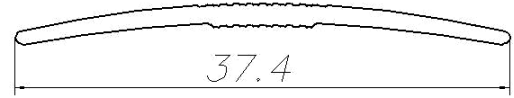

**AT-1097**  
**T=**  
**m = 0.207**



**AT-1098**  
**T= 1.75**  
**m = 0.155**

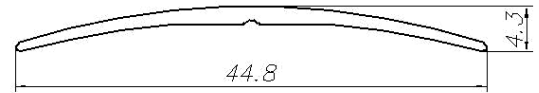

**AT-1099**  
**T= 1.6**  
**m = 0.167**

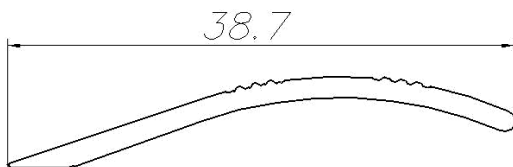

**AT-1106**  
**T=**  
**m = 0.160**

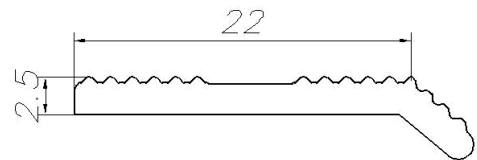

**AT-1179**  
**T= 2**  
**m = 0.142**

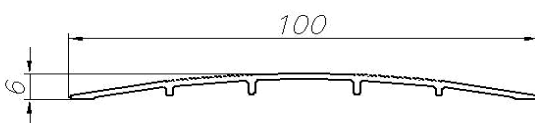

**AT-1332**  
**T= 2.2**  
**m = 0.151**

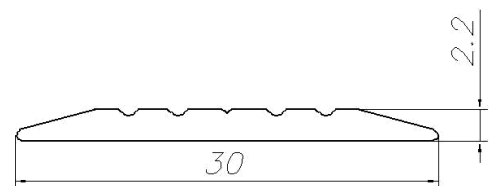

Алюминиевый порожек

**AT-1351**  
**T=**  
**m = 0.164**

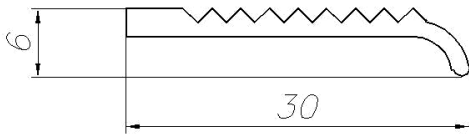

**AT-2490**  
**T= 2.4**  
**m = 0.178**

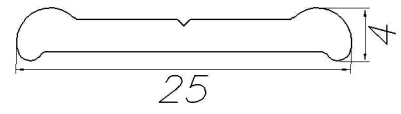

**AT-2526**  
**T= 2**  
**m = 0.168**

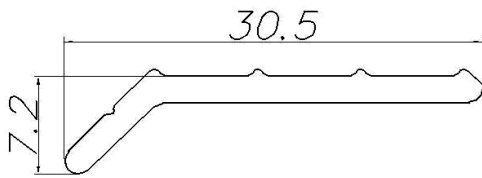

**AT-2527**  
**T= 2.2**  
**m = 0.155**

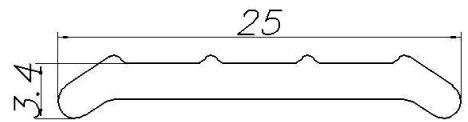

**AT-2702**  
**T= 1.2**  
**m = 0.318**

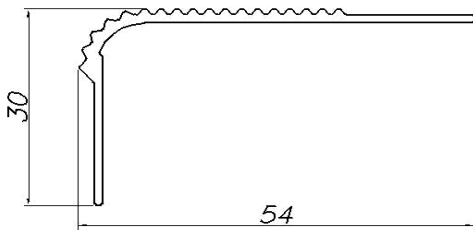

**AT-2703**  
**T= 1.4**  
**m = 0.127**

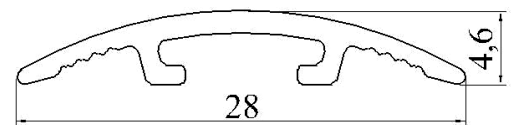

**AT-2704**  
**T= 1.6**  
**m = 0.176**

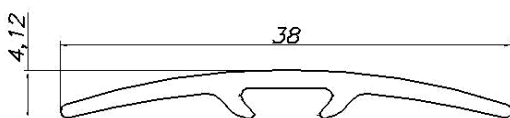

**AT-2705**  
**T= 1.6**  
**m = 0.132**

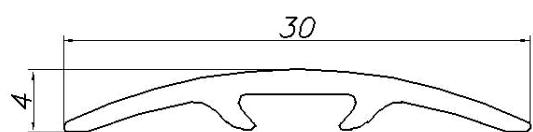

Алюминиевый порожек

**AT-2720**  
**T=**  
**m = 0.141**

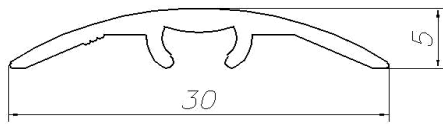

**AT-2721**  
**T= 1.1**  
**m = 0.147**

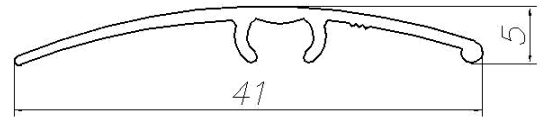

**AT-2770**  
**T= 2**  
**m = 0.108**

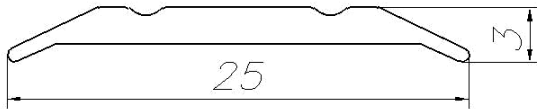

**AT-2862**  
**T= 2.2**  
**m = 0.189**

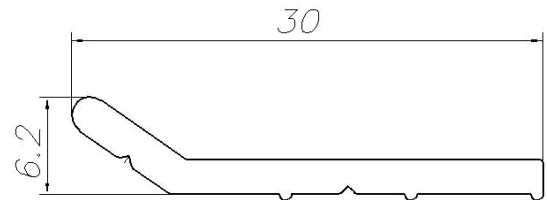

**AT-2878**  
**T= 1.4**  
**m = 0.243**

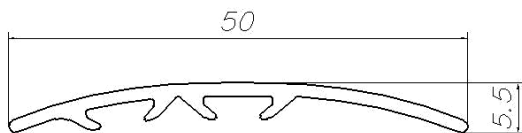

**AT-2944**  
**T= 1.7**  
**m = 0.187**

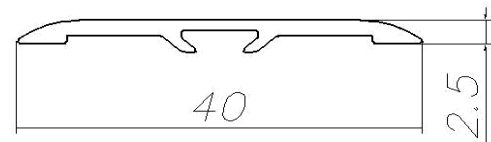

**AT-2966**  
**T= 2.2**  
**m = 0.166**

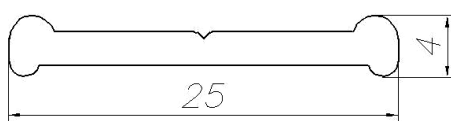

**AT-2967**  
**T= 2.2**  
**m = 0.169**

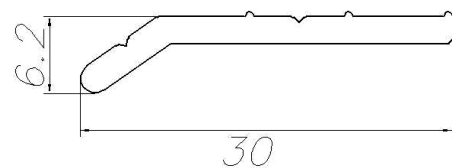

Алюминиевый порожек

**AT-2973**  
T=  
m = 0.172

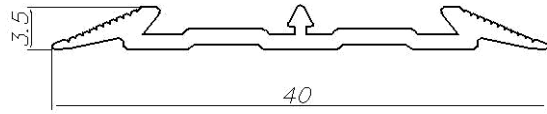

**AT-2974**  
T=  
m = 0.242

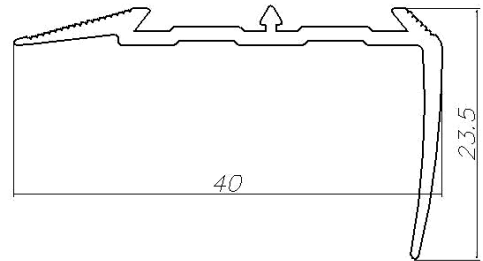

**AT-3006**  
T= 1,5  
m = 0.217

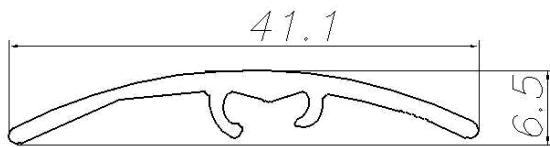

**AT-3528**  
T= 1.2  
m = 0.111

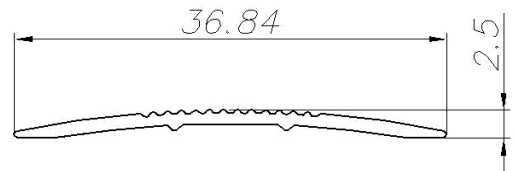

**AT-3529**  
T=  
m = 0.133

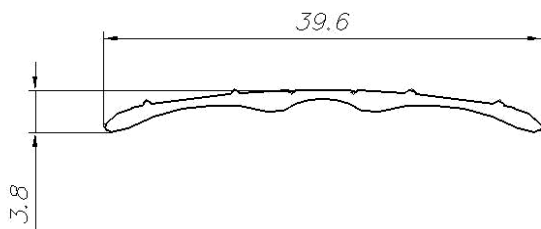

**AT-3530**  
T=  
m = 0.309

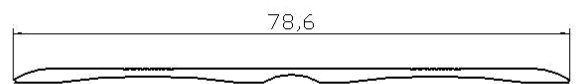

**AT-1363**  
T=  
m = 0.479

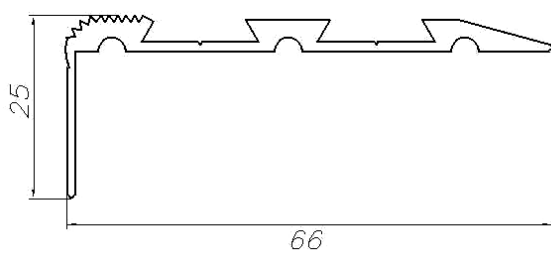

**AT-2753**  
T=  
m = 0.096

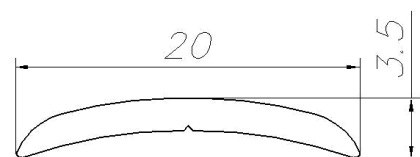

Алюминиевый порожек

**AT-3869**  
**T= 1.5**  
**m = 0.124**

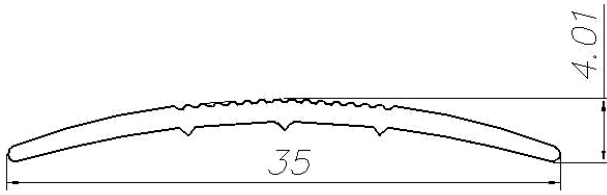

**AT-3988**  
**T=**  
**m = 0.270**

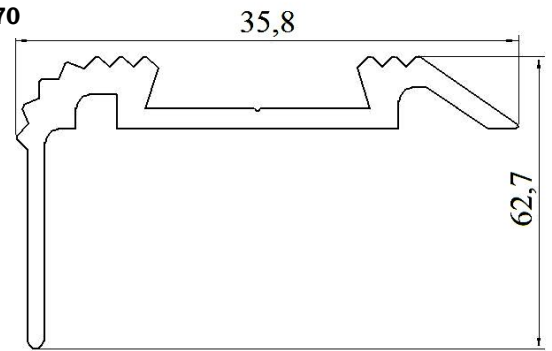

**AT-4241**  
**T=**  
**m = 0.105**

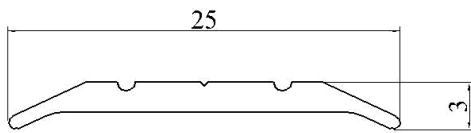

**AT-4242**  
**T=**  
**m = 0.151**

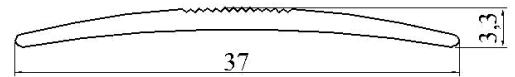

**AT-4264**  
**T=**  
**m = 0.128**

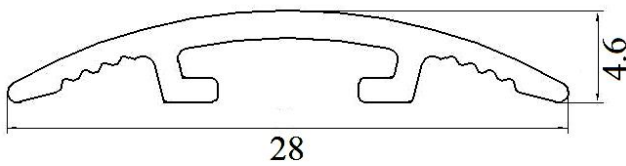

**AT-4426**  
**T= 0.8**  
**m = 0.086**

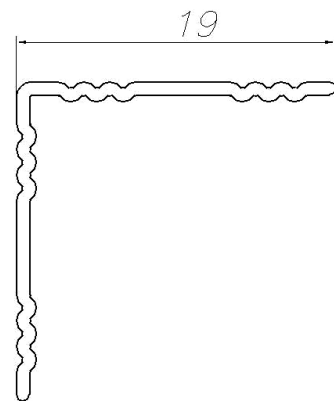

**AT-4427**  
**T= 2**  
**m = 0.171**

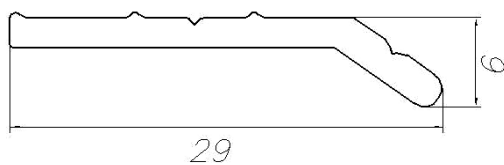

**AT-4428**  
**T= 2**  
**m = 0.147**

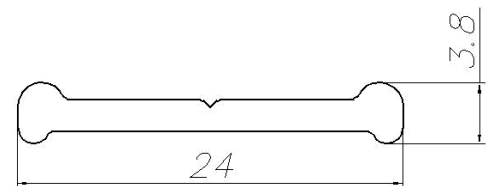

Алюминиевый порожек

**AT-4512**  
**T=**  
**m = 0.127**

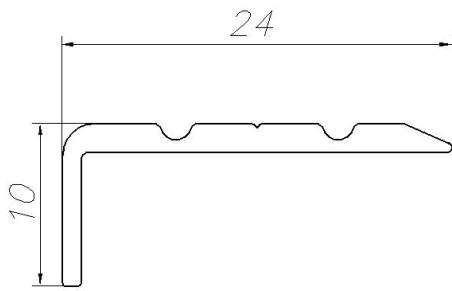

**AT-4513**  
**T=**  
**m = 0.156**

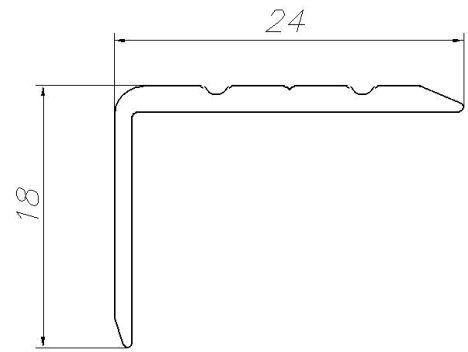

**AT-4514**  
**T=**  
**m = 0.237**

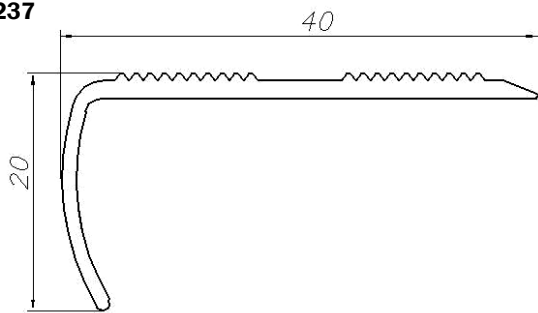

**AT-4515**  
**T= 1.2**  
**m = 0.301**

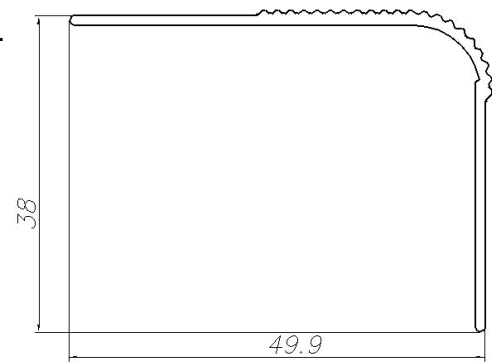

**AT-4579**  
**T=**  
**m = 0.178**

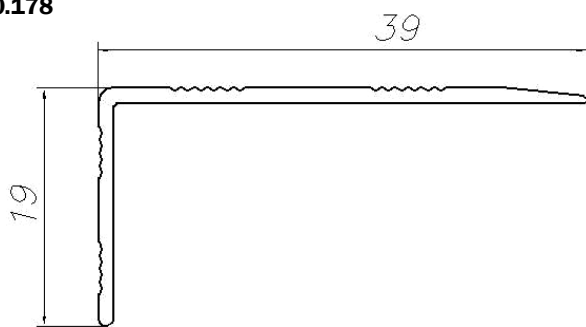

**AT-4706**  
**T= 0.8**  
**m = 0.101**

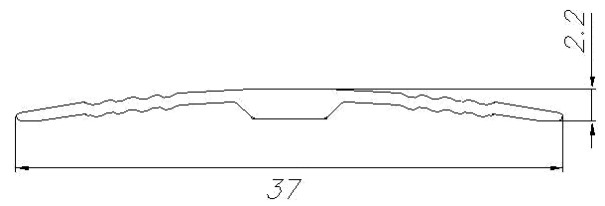

**AT-4707**  
**T= 0.8**  
**m = 0.081**

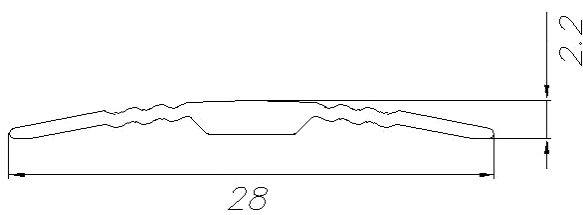

**AT-4719**  
**T=**  
**m = 0.199**

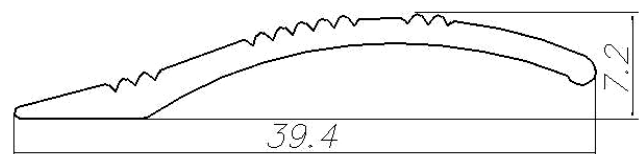



Алюминиевый порожек

**AT-4720**  
T=  
m = 0.217

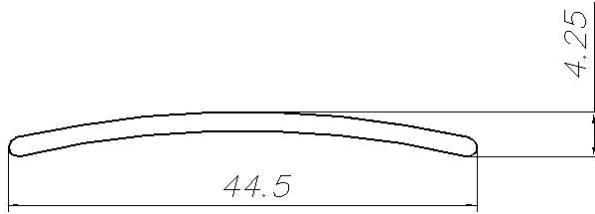

**AT-4721**  
T=  
m = 0.298

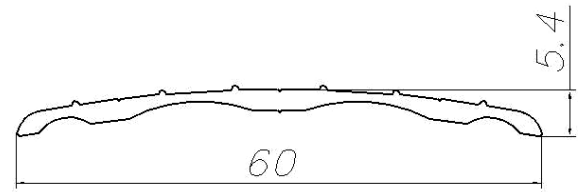

**AT-4722**  
T=  
m = 0.153



**AT-4723**  
T=  
m = 0.102

